

ICP-QQQ-MS for the accurate determination of S in organic matrices

*Lieve Balcaen, Glenn Woods,
Martín Resano and Frank Vanhaecke*

Agilent Spectroscopy Days
11th & 12th of June 2013



Introduction

S determination

ICP-QQQ

Characterisation

Validation

Conclusions

Isotopic analysis

*Trace element
determination*

Speciation



Ecotoxicology

Medicine

Pharmacy

Biology

Geology

Cosmochemistry

Archaeometry

*Elan DRC⁺
Q-ICP-MS*



*XSeries II
Q-ICP-MS*

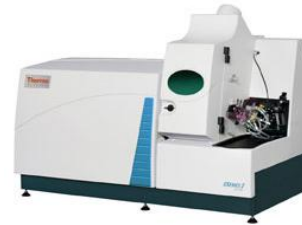

*Agilent 8800
ICP-QQQ*



*Arcos
ICP-OES*



*Spectro MS
Mattauch-Herzog ICP-MS*



*Element XR
SF-ICP-MS*



*Neptune
MC-ICP-MS*

ONE OF OUR RESEARCH PROJECTS...

- Pharmaceutical research
 - metabolism study:
 - Chromatographic separation of metabolites
 - Quantification of metabolites bound to glutathione (via S)

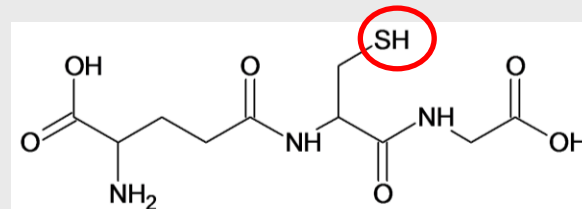

HPLC-ICP-MS

- Separation of metabolites: reversed-phase HPLC
 - **Gradient elution:** 95% NH_4Ac → 90% CH_3OH
- Quantification: ICP-MS
 - Calibration: online **isotope dilution**
 - interference-free determination of ^{32}S and ^{34}S
 - quadrupole ICP-MS: spectral interferences

SPECTRAL INTERFERENCES

Analyte	Abundance (%)	Ions causing spectral interference
$^{32}\text{S}^+$	95.04	$^{16}\text{O}^{16}\text{O}^+$, $^{14}\text{N}^{18}\text{O}^+$, $^{15}\text{N}^{16}\text{O}^{1}\text{H}^+$
$^{33}\text{S}^+$	0.75	$^{32}\text{S}^{1}\text{H}^+$, $^{16}\text{O}^{16}\text{O}^{1}\text{H}^+$, $^{16}\text{O}^{17}\text{O}^+$, $^{15}\text{N}^{18}\text{O}^+$, $^{14}\text{N}^{18}\text{O}^{1}\text{H}^+$
$^{34}\text{S}^+$	4.20	$^{33}\text{S}^{1}\text{H}^+$, $^{16}\text{O}^{18}\text{O}^+$

→ quadrupole ICP-MS with reaction/collision cell:



SPECTRAL INTERFERENCES

Analyte	Abundance (%)	Ions causing spectral interference
$^{32}\text{S}^{16}\text{O}^+$	95.04	$^{48}\text{Ti}^+$, $^{48}\text{Ca}^+$, $^{36}\text{Ar}^{12}\text{C}^+$
$^{33}\text{S}^{16}\text{O}^+$	0.75	$^{49}\text{Ti}^+$, $^{32}\text{S}^{17}\text{O}^+$
$^{34}\text{S}^{16}\text{O}^+$	4.20	$^{50}\text{Ti}^+$, $^{50}\text{Cr}^+$, $^{50}\text{V}^+$, $^{38}\text{Ar}^{12}\text{C}^+$, $^{36}\text{Ar}^{14}\text{N}^+$, $^{32}\text{S}^{18}\text{O}^+$, $^{33}\text{S}^{17}\text{O}^+$

→ ICP-DRC-Q-MS only partial solution

(use of sector field – ICP – MS (more expensive – less robust))

2012: AGILENT 8800 ICP-QQQ

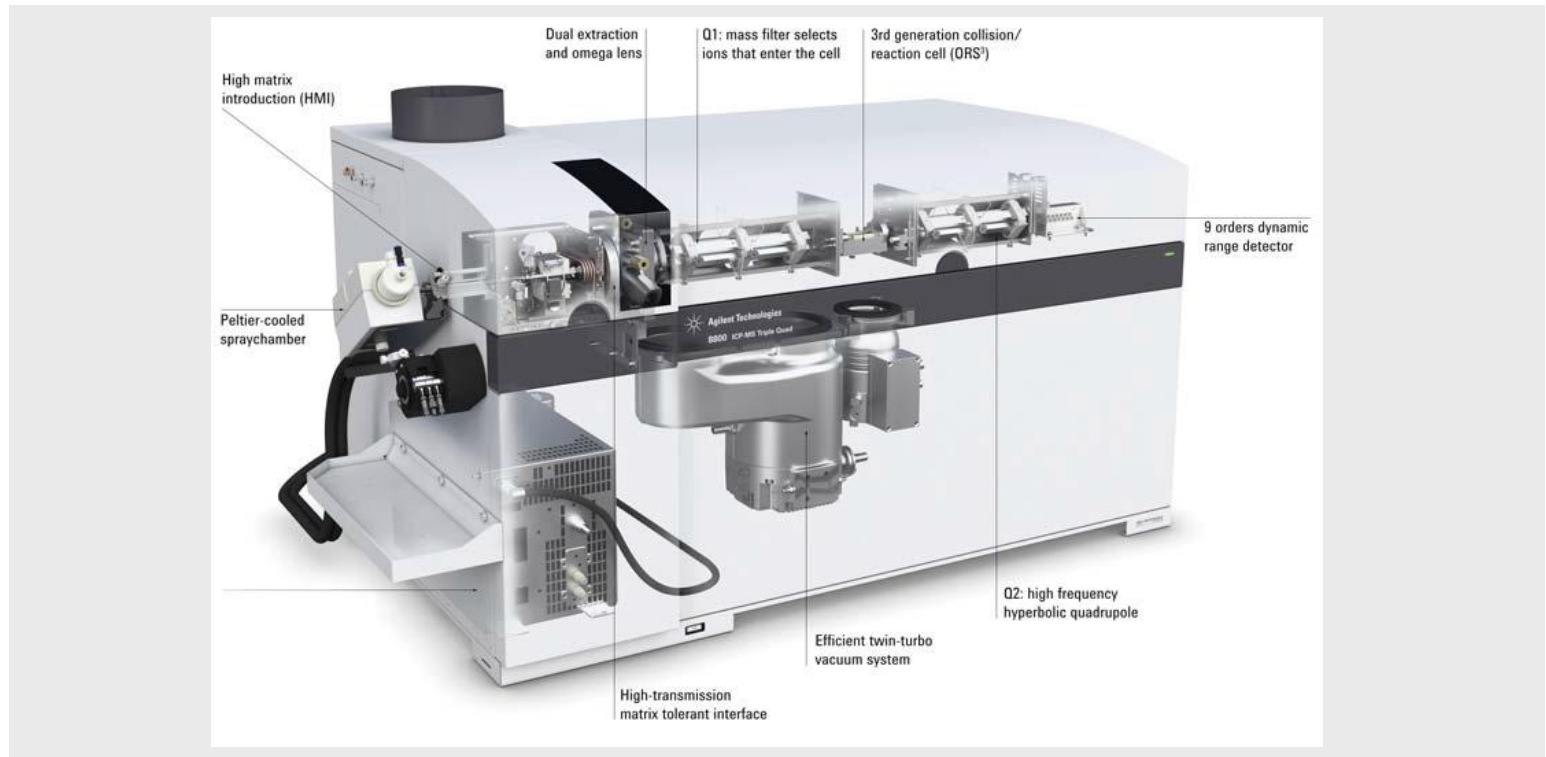

AGILENT 8800

- $S^+ \rightarrow SO^+$ - S detection at $m/z=48$ and 50
- MS/MS mode: avoid interferences on $m/z= 48$ and 50 ?

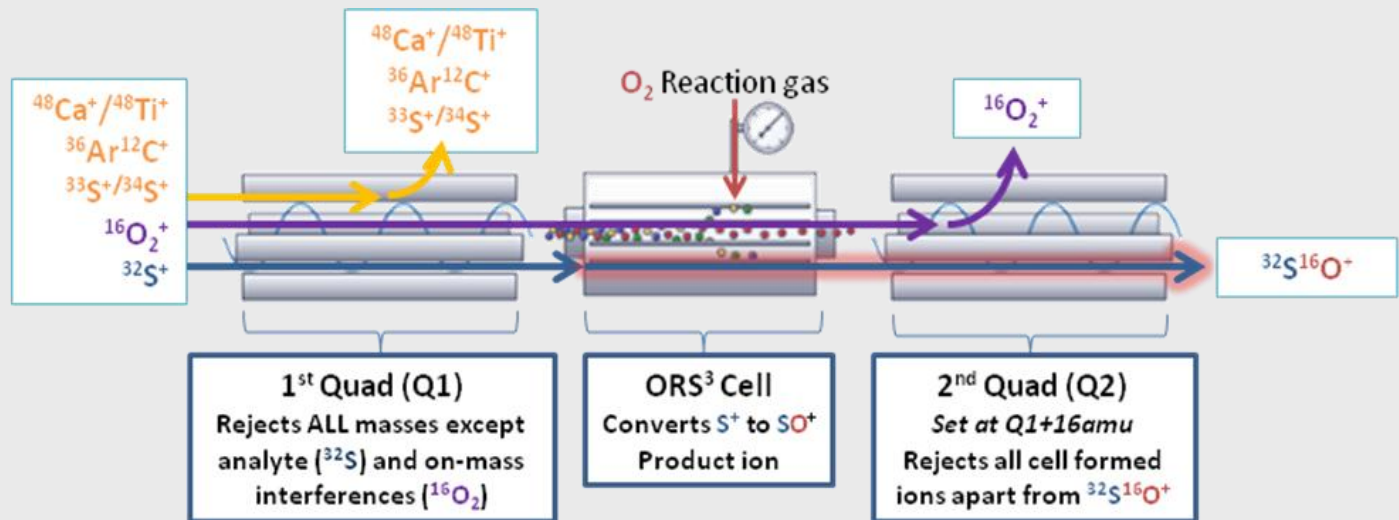

DETERMINATION of S in pure ETHANOL

- S – standards in pure ethanol (0 to 850 $\mu\text{g L}^{-1}$ S)
 - Spray chamber : - 5 °C
 - 1 mm i.d. injector (standard: 2.5 mm)
 - O₂ (20% in Ar) to avoid carbon build-up
 - O₂ reaction gas: optimization of gas flow

OPTIMIZATION REACTION GAS FLOW (O_2)

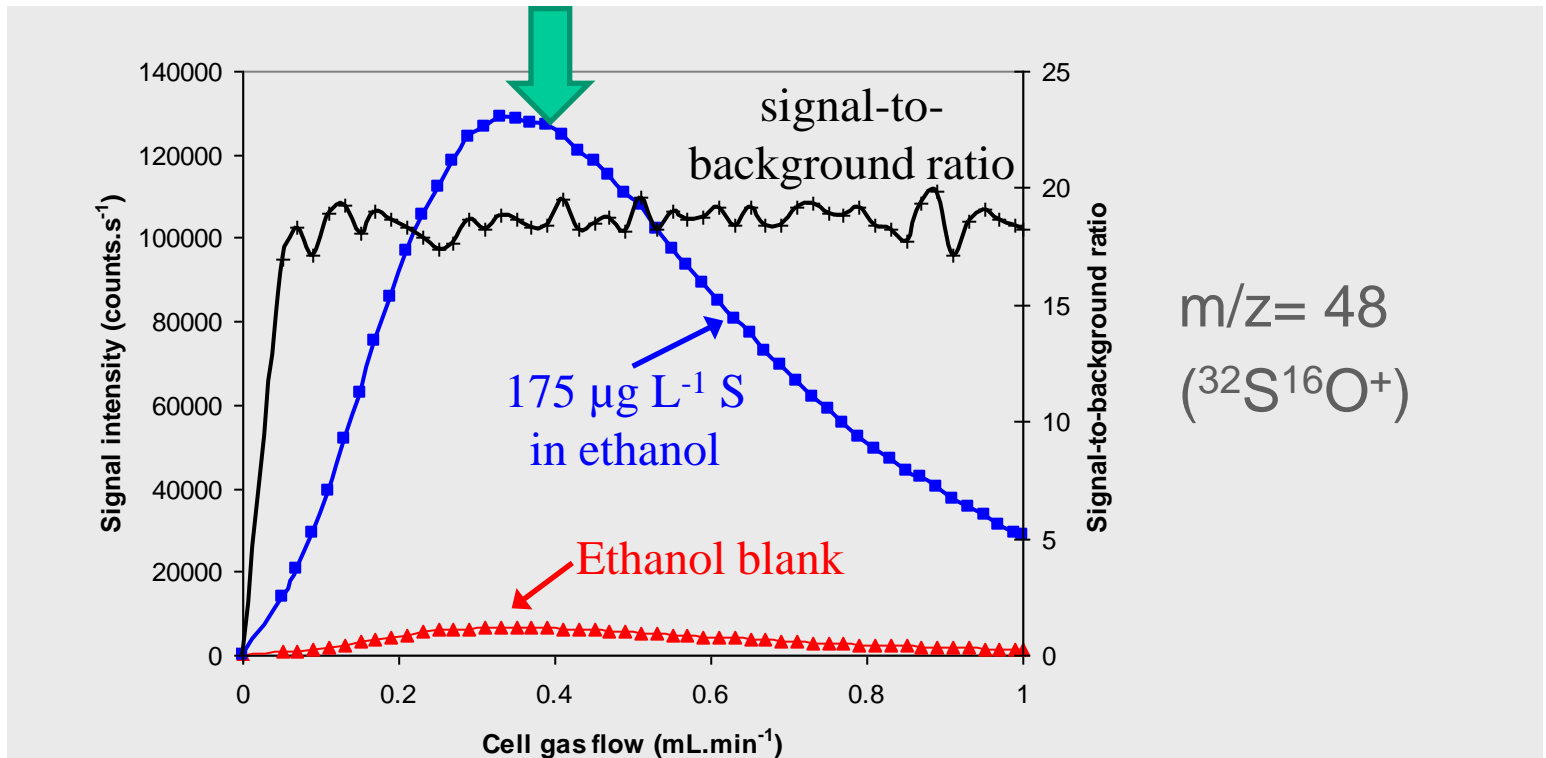

CALIBRATION CURVES – standard mode

- 3 MODES:
 - 'ion guide' mode (single-Q ~ Q1: ion guide ~ no reaction)

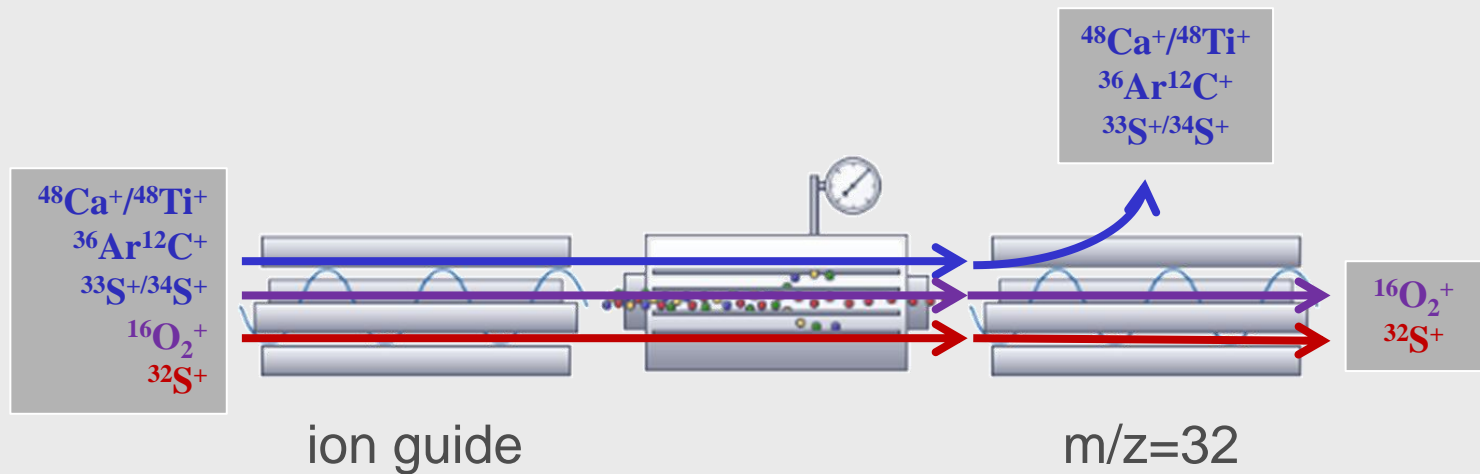

CALIBRATION CURVES – bandpass mode

- 3 MODES:
 - 'ion guide' mode (single-Q ~ Q1: ion guide ~ no reaction)
 - 'bandpass' mode (single-Q ~ Q1: bandpass filter ~ reaction)

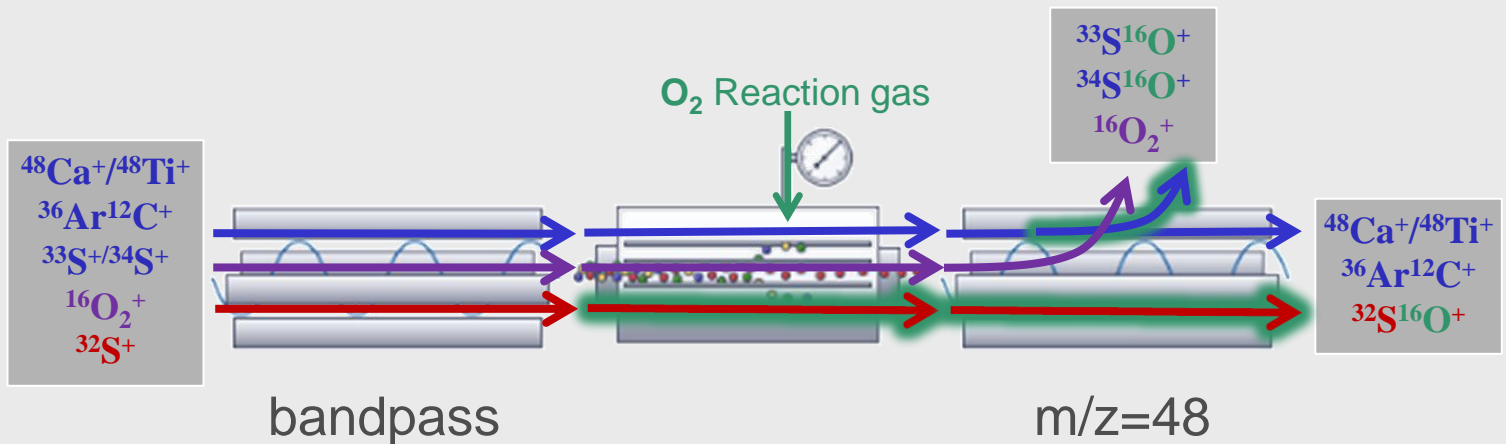

CALIBRATION CURVES – MS/MS mode

- 3 MODES:
 - 'ion guide' mode (single-Q ~ Q1: ion guide ~ no reaction)
 - 'bandpass' mode (single-Q ~ Q1: bandpass filter ~ reaction)
 - 'MS/MS' mode (triple-Q ~ Q1: precursor ion mass ~ reaction)

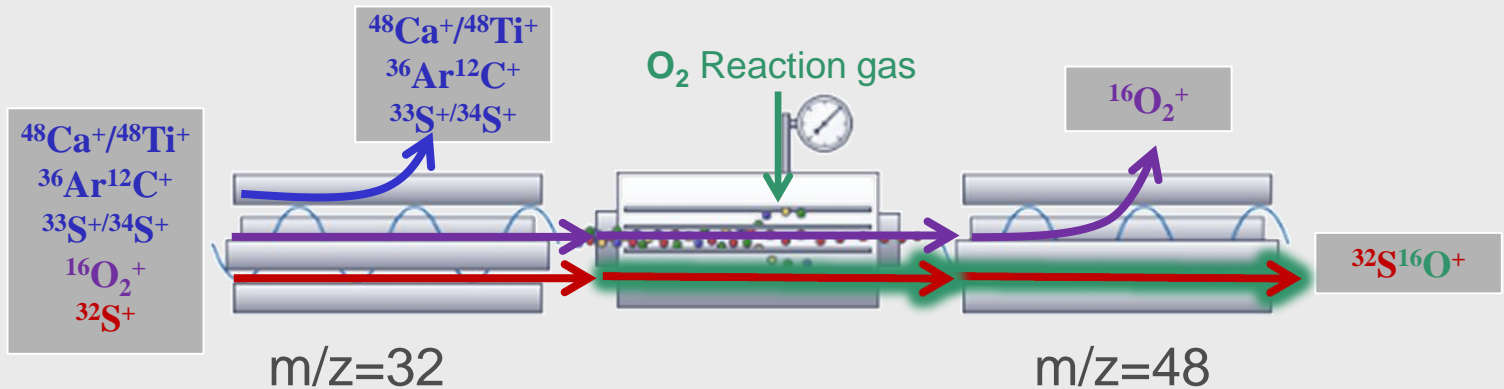

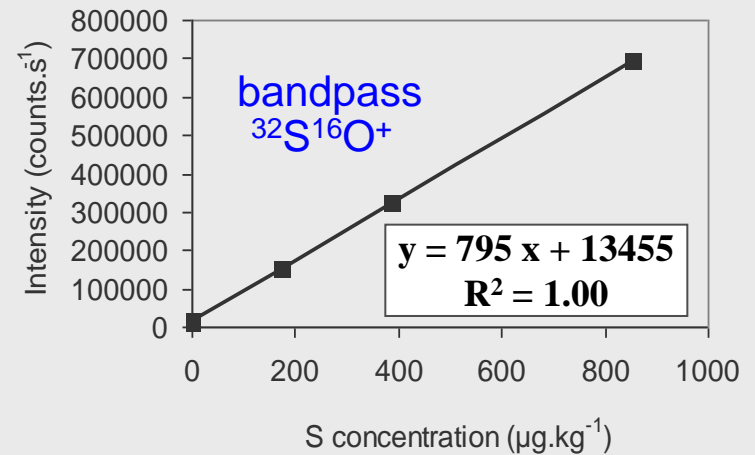
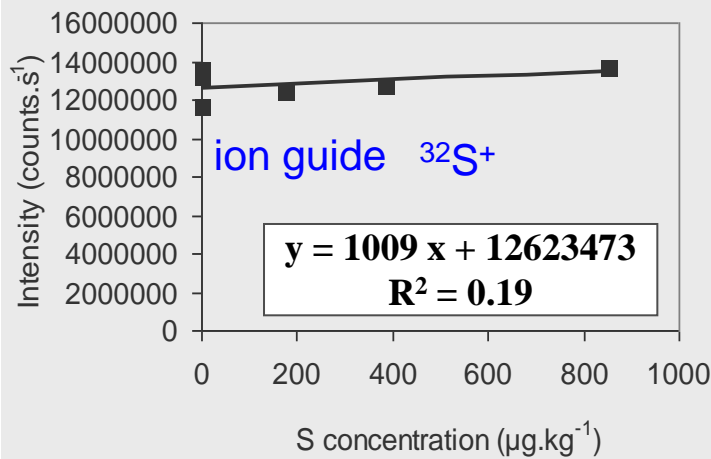

^{32}S

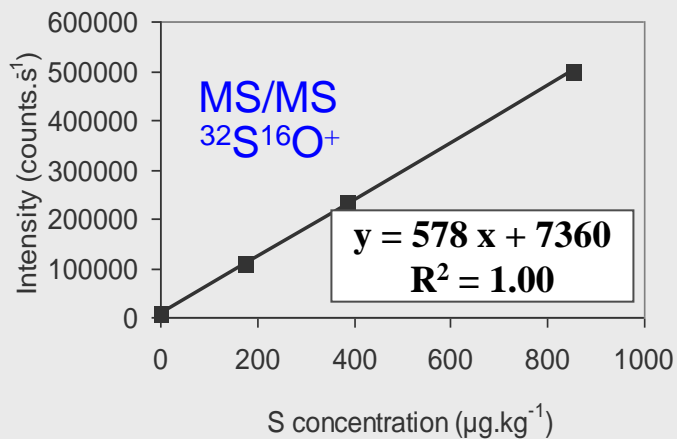

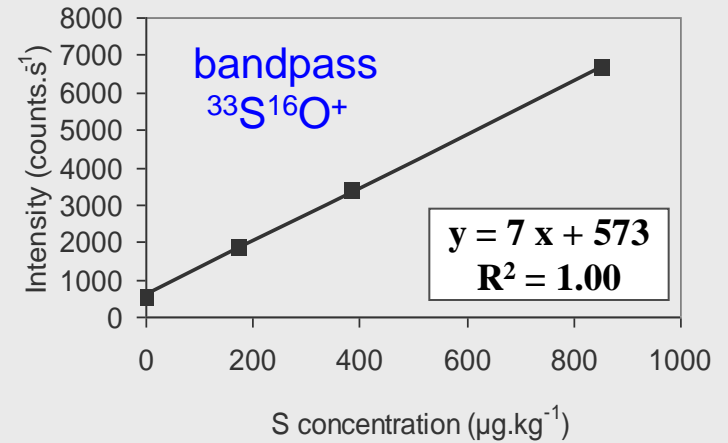
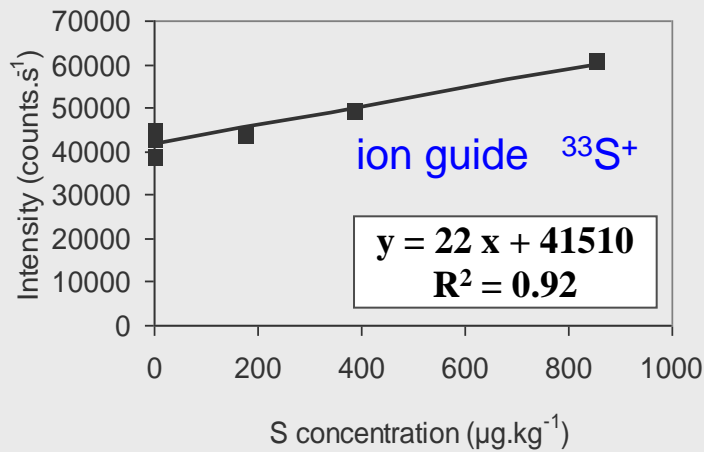

^{33}S

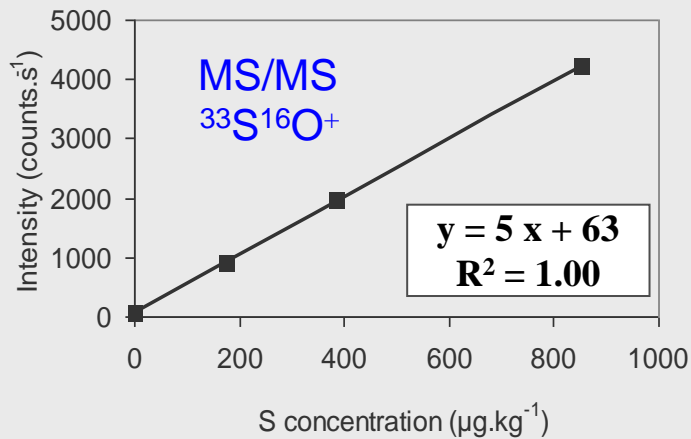

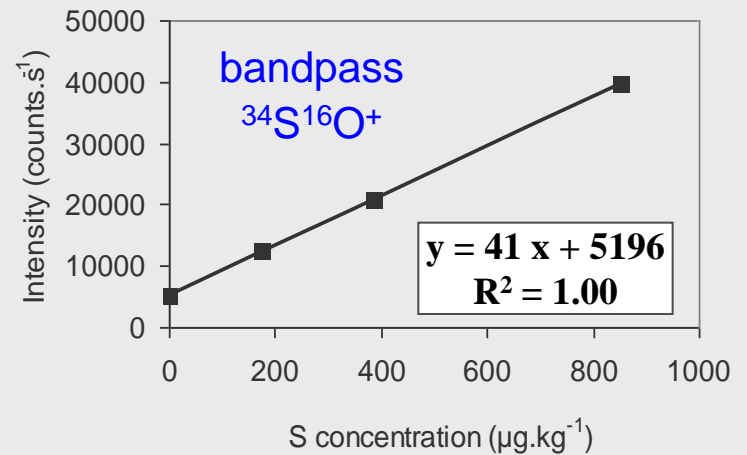
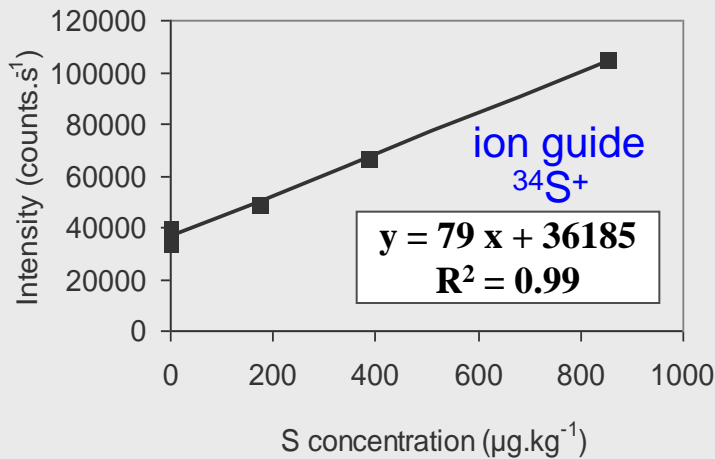

³⁴S

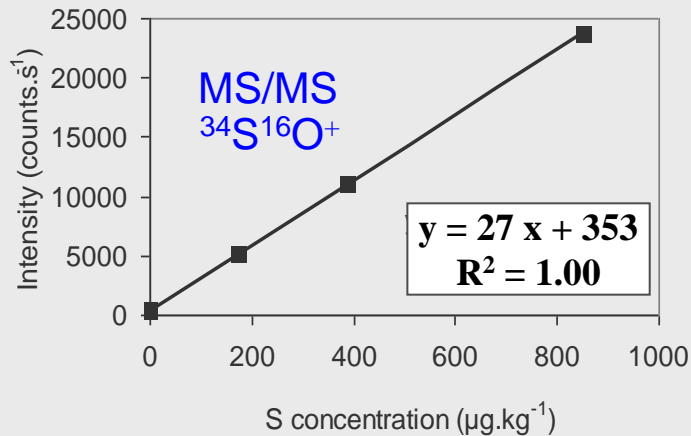

COMPARISON BANDPASS & MS/MS MODE

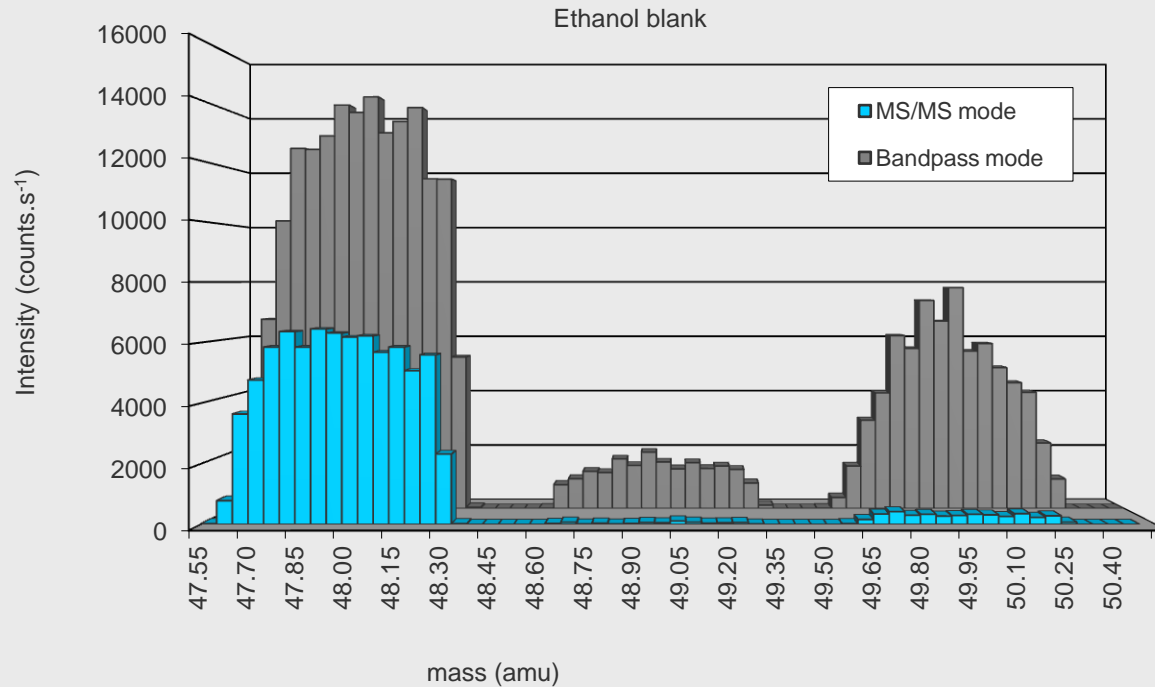

COMPARISON BANDPASS & MS/MS MODE

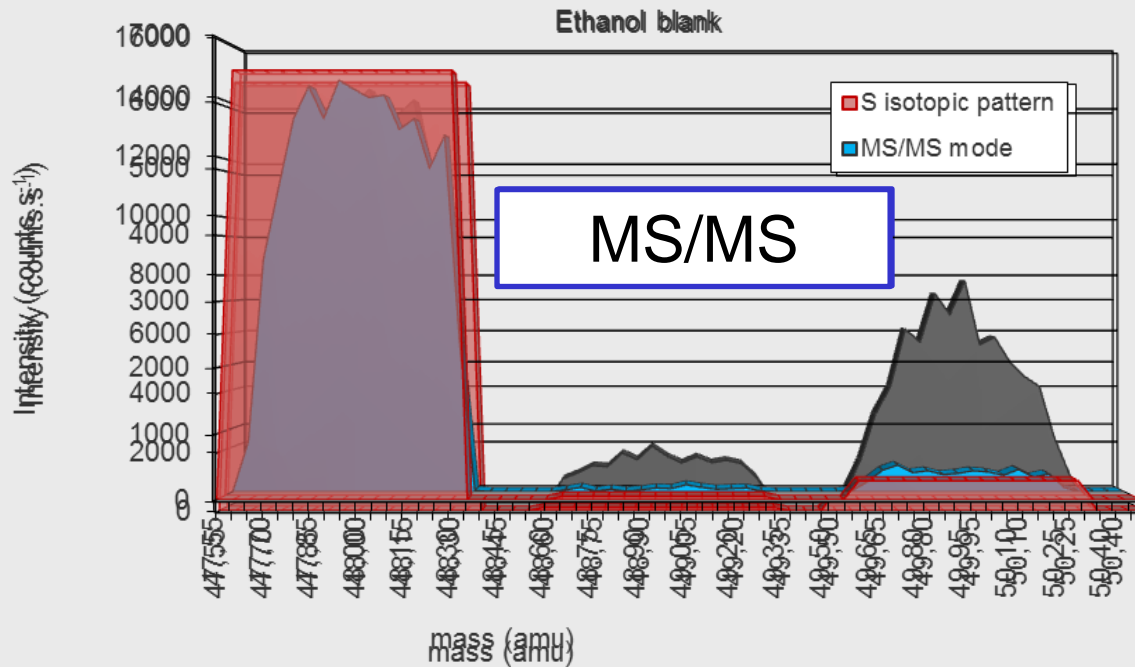

LET'S MAKE LIFE EVEN MORE COMPLEX...

- Matrix: Ethanol + 50 $\mu\text{g}\cdot\text{L}^{-1}$ Ca + Ti

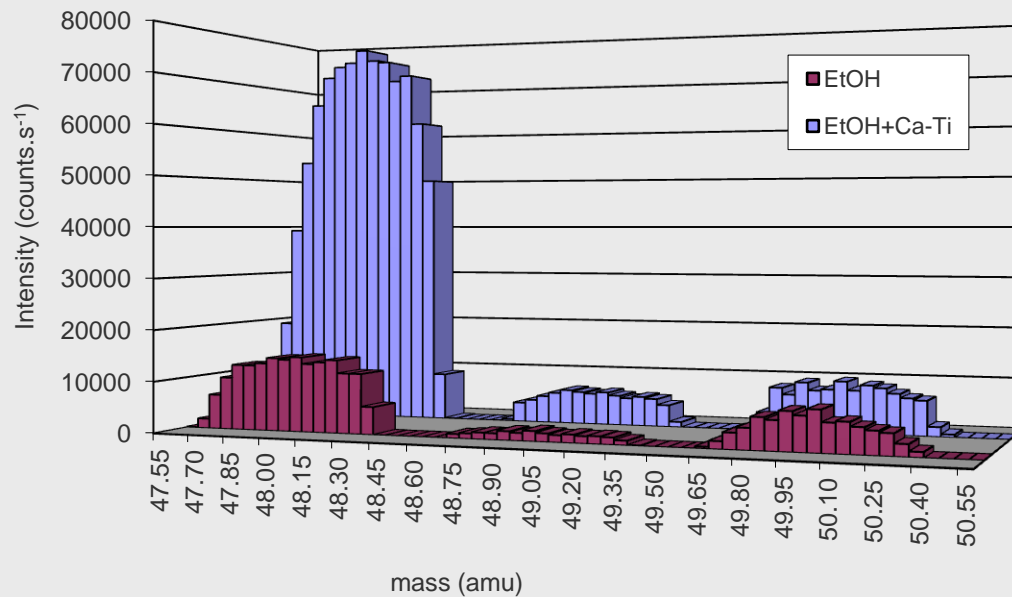

Bandpass
mode

LET'S MAKE LIFE EVEN MORE COMPLEX...

- Matrix: Ethanol + 50 $\mu\text{g.L}^{-1}$ Ca + Ti

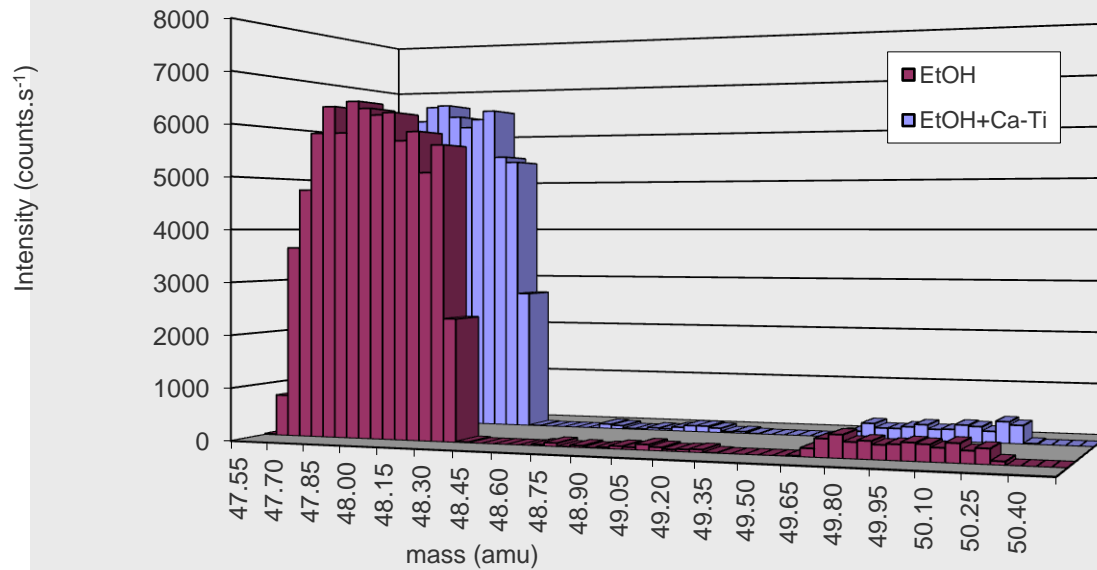

MS/MS
mode

LIMIT OF DETECTION (LOD)

LOD ($\mu\text{g.L}^{-1}$)	^{32}S	^{33}S	^{34}S
MS/MS (s (external))	4	3	6
MS/MS (s (internal))	0.4	5	1.6
<i>Literature values</i>			
<i>reaction cell ICP-MS</i>	<i>10 - 100</i>		<i>300</i>
<i>sector field ICP-MS</i>	<i>1</i>		<i>2</i>

VALIDATION: Analysis of SRM 2773 biodiesel

- NIST SRM 2773: animal-based biodiesel
 - Isotope dilution for calibration
 - Simple dilution with ethanol
- Sample preparation:



~ 1 g biodiesel

~ 0.2 g ^{34}S spike
($0,711 \mu\text{g mol}^{-1} \text{ }^{34}\text{S}$)



24 mL ethanol

VALIDATION: Analysis of SRM 2773 biodiesel

Parameter	Value
RF power	1450 W
Carrier gas flow rate	0.98 L min ⁻¹
O ₂ option gas flow rate	75 mL min ⁻¹
Spray chamber temp.	- 5 °C
O ₂ reaction gas flow rate	0.4 mL min ⁻¹
Q1 bias	- 2 V
Octopole bias	- 9V
Q2 bias	- 18V

VALIDATION: Analysis of SRM 2773 biodiesel

Q1: $m/z = 32 / 34$ ~ Q2: $m/z = 48 / 50$

	Concentration	Certified value
SRM 2773 – 1	7.234 mg g ⁻¹	
SRM 2773 – 2	7.227 mg g ⁻¹	
SRM 2773 – 3	7.231 mg g ⁻¹	
Average	7.231 mg g⁻¹	7.39 ± 0.39 mg g⁻¹
S	0.003 mg g ⁻¹	
95% CI	7.231 ± 0.015 mg g ⁻¹	

CONCLUSIONS

- Analysis of organic matrices is possible
- Almost interference-free determination of ^{32}S , ^{33}S and ^{34}S , independent of the matrix
- Accurate results obtained for a biodiesel SRM
- Flexible, all-round instrument
 - “normal” quadrupole-based ICP-MS
 - large range of possibilities to deal with interferences

