

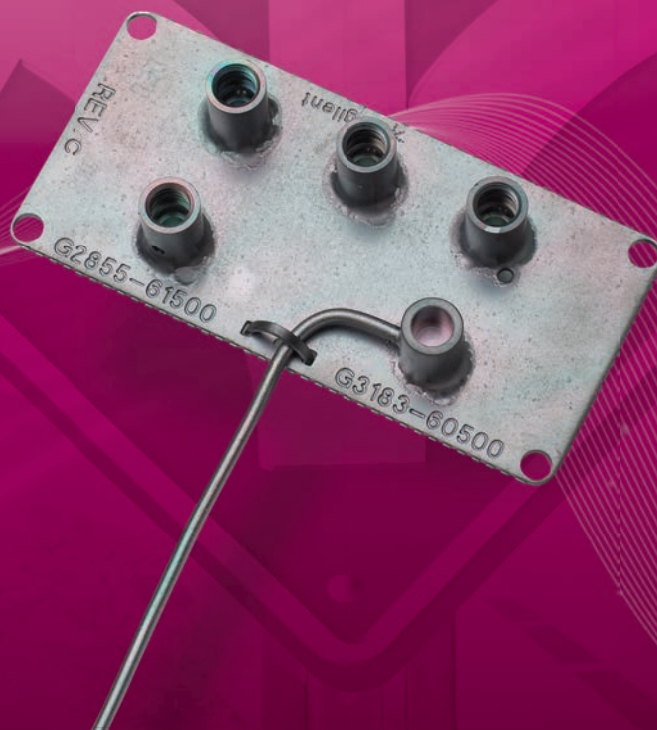

Capillary Flow Technology: Splitters

GET MORE INFORMATION IN LESS TIME

The Measure of Confidence



Agilent Technologies

A time-saving alternative to running samples on multiple GCs

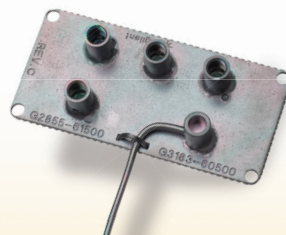

Analyzing complex samples may require different types of specific GC detectors in order to meet detection limits, overcome matrix interferences, or confirm unknown peaks. Forensic analysis often requires mass spectrometry to produce defensible data for possible use in a criminal trial. Therefore, it is not unusual in such situations to run a sample multiple times on different GC systems, each with a dedicated detector. Agilent offers a time-saving alternative: use our Capillary Flow Technology Splitter to split effluent from a single column to two or three detectors on the same GC.

While the use of splitters is not new, the technique has been limited in its use due to technical challenges with the splitting hardware. For instance, optimal performance requires that a splitter be inert, have low thermal mass and dead volume, be leak free, allow no outgassing from sealing materials, and be capable of withstanding the temperatures used in the GC analysis.

HERE'S HOW AGILENT'S TECHNOLOGY OVERCOMES PREVIOUS SPLITTER CHALLENGES:

Challenges	The Agilent Solution
<p>With traditional splitters:</p> <ul style="list-style-type: none">■ Glass "Y" connectors can be difficult to assemble correctly, and the column or fused silica tubing can sometimes detach upon thermal cycling of the oven.■ Some splitters use polyimide ferrules, which can outgas at high temperatures and develop leaks upon thermal cycling due to shrinkage of the polymer.■ Graphite ferrule splitters eliminate thermal cycling problems but may have trouble with inertness; they can outgas contaminants at high temperatures and can shed active particles into the sample path.■ There is the risk of atmospheric detector gas "leaking" into the mass spectrometer if make-up gas is not used for pressure compensation.■ The split ratio on various detectors depends on the length and internal diameter (i.d.) of the restrictor tubing. Selecting the correct dimensions requires calculations that can impact the chromatography, especially if using a mass spectrometer (vacuum).	<p>With Agilent's Capillary Flow Technology Splitter modules:</p> <ul style="list-style-type: none">■ The column and restrictors leading to the detectors attach to the module using metal ferrules that do not outgas, do not shed particles, will not detach, and eliminate leaks (even after oven cycles with temperatures as high as 350 °C).■ All surfaces are deactivated for a completely inert sample path.■ Aux EPC can be used to ensure there is no backflow of gas from a GC detector to an MSD, protecting the source from possible damage.■ A simple calculator, based on Microsoft® Excel, is used to determine the restrictor dimensions needed to attain a specific split ratio. See tips and tools for more information.

How it works...

AGILENT OFFERS SEVERAL DIFFERENT SPLITTERS THAT USE OUR PROPRIETARY CAPILLARY FLOW TECHNOLOGY

1. Two-way splitter without makeup gas. This splitter divides the column effluent to two different detectors. It is useful for labs that set up a single configuration and use it without changing columns or parameters frequently. It is best used with column flows greater than 2 mL/min and with atmospheric pressure detectors. While it can be used for splitting to an MSD if care is taken in the setup, a two-way or three-way splitter with makeup gas is strongly recommended for MSD applications.

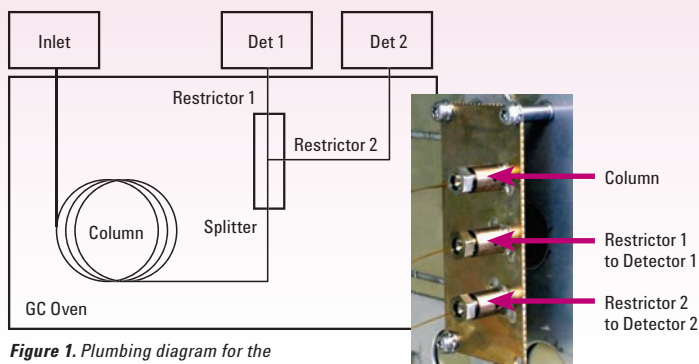

Figure 1. Plumbing diagram for the two-way splitter without makeup gas

Figure 2. Two-way splitter without makeup gas connections

2. Two-way splitter with makeup gas. This splitter uses a source of makeup gas supplied by electronic pneumatics control (EPC). Use of an Aux EPC module maintains the splitter at a known and constant pressure, which allows easier splitting to vacuum detectors such as the MSD. It simplifies the choice of splitter parameters, allowing all aspects of the chromatographic setup to be calculated. Constant pressure makeup allows the column to be run in constant flow mode. At the same time, a constant split ratio is maintained between two detectors of different operating pressures, such as the FPD and the MSD. Because the EPC pressure can be time programmed, useful operations like backflushing unwanted heavy materials from the column and changing columns in MSD systems without venting, are possible.

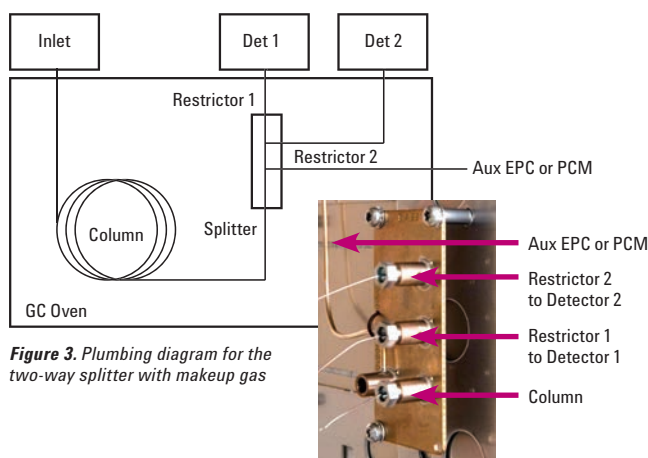

Figure 3. Plumbing diagram for the two-way splitter with makeup gas

Figure 4. Two-way splitter with makeup gas connections

3. Three-way splitter with makeup gas. This splitter operates the same as the two-way splitter with makeup gas, but divides the effluent from a column among three different detectors.

Note: A purged capillary flow device, such as a splitter, introduces an additional flow in the sample stream. For detectors that operate at low flow rates, like the MSD and TCD, some decrease in sensitivity will occur.

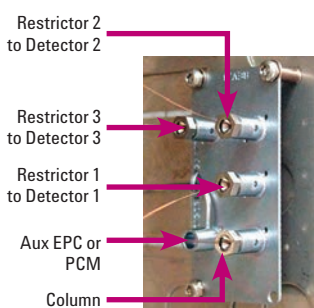

Figure 6. Three-way splitter with makeup gas connections

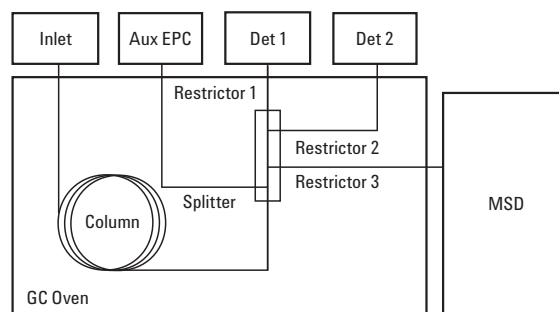

Figure 5. Plumbing diagram for the three-way splitter with makeup gas

Simultaneously collect data from multiple detectors

Laboratories that perform toxicology screens on forensic samples must rise to the challenge of having to analyze large numbers of samples containing complex matrix interferences. The Agilent system addresses these demands by combining fast GC to reduce the run time; the use of a Capillary Flow Technology splitter to simultaneously collect scan, SIM, and

NPD data and backflush to prevent heavy matrix components from fouling the detectors; and Deconvolution Reporting Software (DRS) to simplify data interpretation. Total time savings was greater than 85%, not including the time saved by using DRS.

Rapid Forensic Toxicology Screening Using an Agilent GC/MSD System using deconvolution reporting software (DRS)

Agilent Application Note 5989-6066EN

Industries: Forensics, Drug Testing

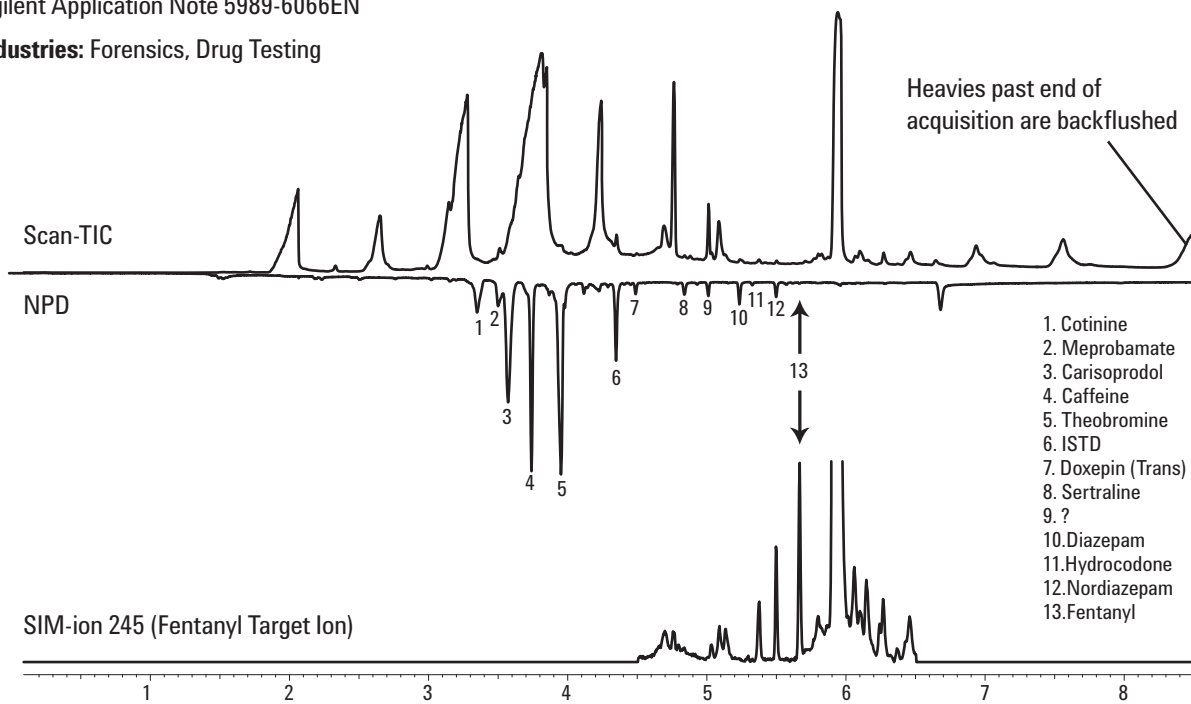

Figure 7. Chromatogram from screen of whole blood sample

Detect unknown trace pesticide residue without full-scan MS

Fruit and vegetable extracts are typically very complex to analyze. It is common to use selective GC detectors, such as NPD, ECD, and FPD, to look for trace pesticide residues in the extracts. Mass spectrometry is most often used to confirm the hits from GC detectors. **Figure 8** shows how the column effluent can be split three ways to two GC detectors and an MSD. The splitter system is therefore capable of providing up to four

signals (two GC signals, SIM, and full-scan chromatograms) from a single injection. By combining RTL, element-selective detector chromatograms, and the RTL pesticide database, a trace level pesticide residue was identified without the full-scan mass spectrum.

Using RTL and 3-Way Splitter to Identify Unknown in Strawberry Extract

Agilent Application Note 5989-6007EN

Industries: Environmental, Foods

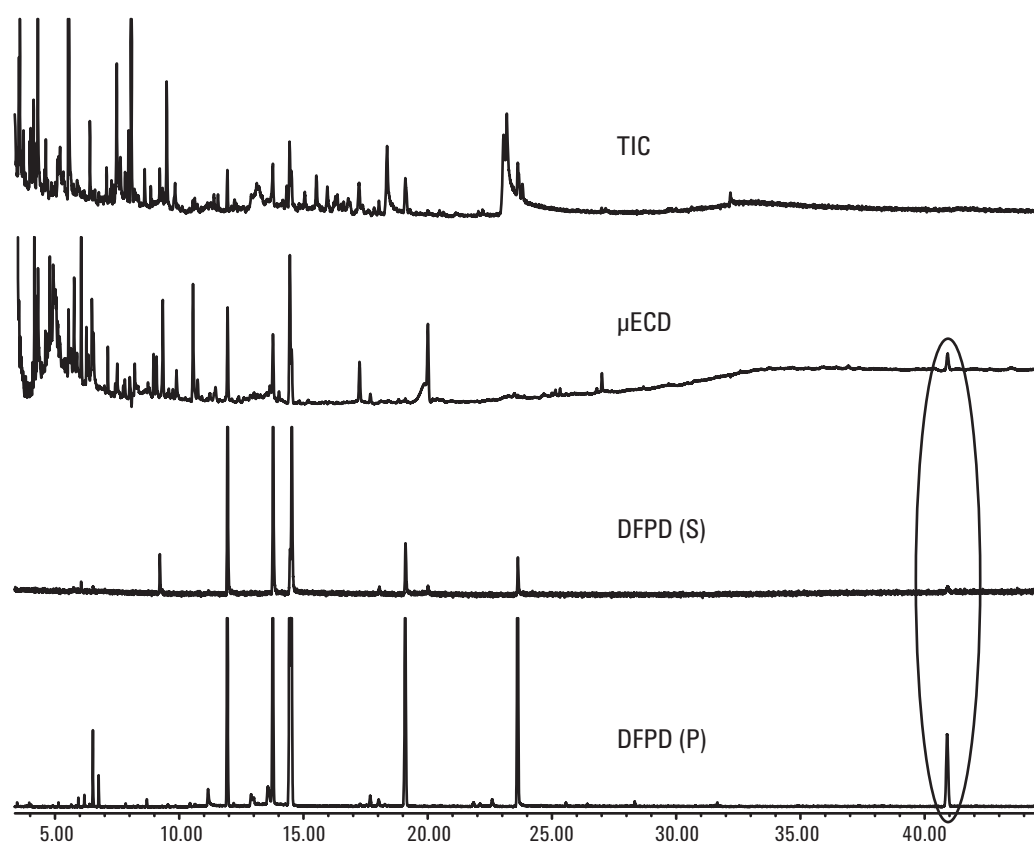

Figure 8. Unknown compound detected by GC signals not found in strawberry extract TIC

Backflush reduces sample turnaround time

This example illustrates the use of a two-way splitter with makeup gas to backflush late-eluting impurities and high-boiling solvents/diluents in the analysis of residual solvents by headspace extraction and GC. Along with a faster oven cool-down possible with the 7890 GC, backflushing decreases the sample turnaround time.

Improved Retention Time, Area Repeatability, and Sensitivity for Analysis of Residual Solvents

Agilent Application Note
5989-6079EN

Industries: Pharmaceutical

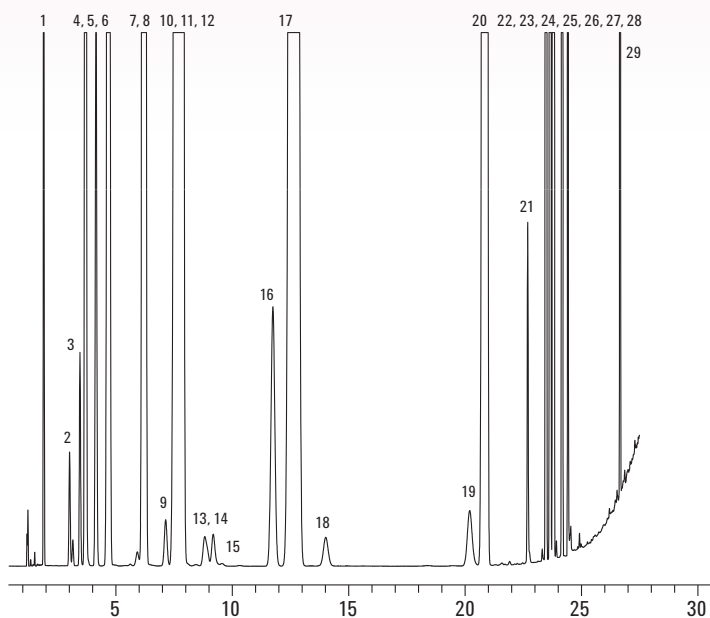

Figure 9. Class 1 and class 2 residual solvents

1. Methanol
2. 1,1 Dichloroethylene
3. Acetonitrile
4. Methylene chloride
5. Trans 1,2 dichloroethene
6. Hexane
7. Cis 1,2 dichloroethene
8. Nitrobenzene (co-elute with 7)
9. Trichloromethane
10. Carbon tetrachloride
11. Cyclohexane (co-elute with 10 and 12)
12. 1,1,1 trichloroethane (co-elute with 10 and 11)
13. Benzene
14. 1,2 dimethoxyethane
15. 1,2 dichloroethane
16. Trichloroethylene
17. Methyl cyclohexane
18. 1,4 dioxane
19. Pyridine
20. Toluene
21. 2 hexanone
22. Chlorobenzene
23. Ethylbenzene
24. DMF
25. M-xylene
26. P-xylene
27. O-xylene
28. N,N dimethylacetamide
29. Tetralin

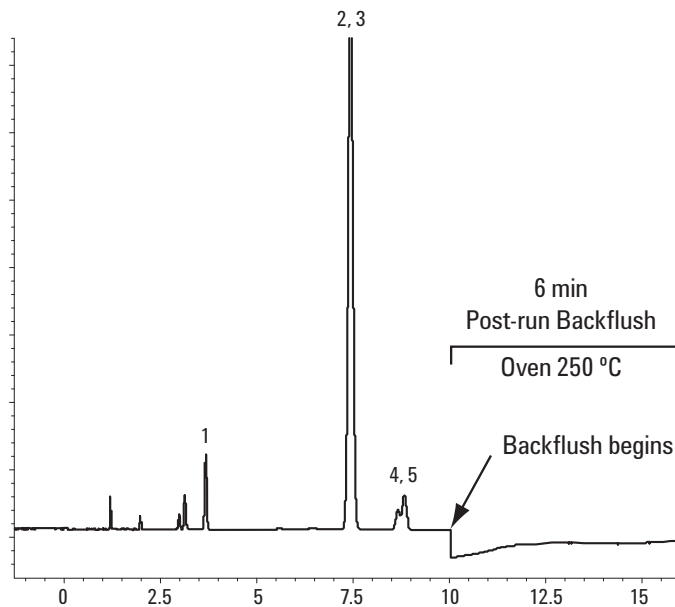

Figure 10. Backflush of class 1 residual solvents

1. 1,1 dichloroethene
2. Carbon tetrachloride
3. 1,1,1 trichloroethane
4. Benzene
5. 1,2 dichloroethane

Other uses for a three-way splitter

Think of Capillary Flow Technology modules as flow “building blocks” that can be configured in different ways to accomplish different tasks. For instance:

Two-Way Splitter

By plugging one of the ports, a three-way splitter can be used as a two-way splitter. A typical three-way splitter plumbing configuration is shown in **Figure 11**.

Figure 12 depicts how the three-way splitter is converted to a two-way splitter. Port 1 is plugged (the plug can be made from a nut and ferrule plus a short length of stainless steel wire included in the splitter kit) and the column is connected to port 2. The two detector restrictors are connected to ports 3 and 4.

Two Different Columns In, Two Detectors Out

Using the setup shown in **Figure 13**, a method can be used to inject into inlet 1 and column 1 while column 2 is unused. Inlet 2 pressure is set at a low level that produces a small purge flow (at least 0.5 mL/min) through column 2. A second method can reverse the situation, purging column 1 while analyzing with inlet 2 and column 2.

This can be useful for laboratories that frequently need to use columns with different phases. Setup is the same as that for a two-way splitter, except that column flow in the calculations now equals the sum of the flows from columns 1 and 2.

Because the bleed from both columns enters the detectors simultaneously, low-bleed stationary phases should be used in this configuration.

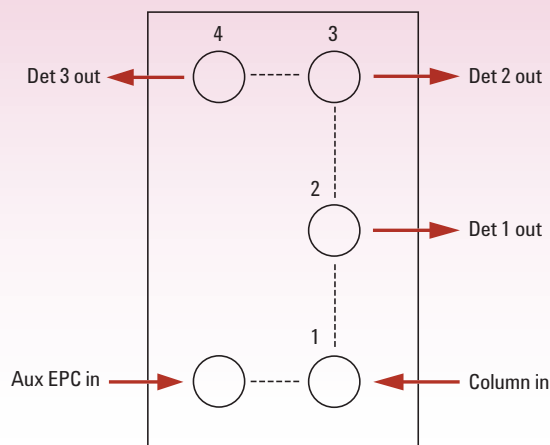

Figure 11. Typical three-way splitter plumbing configuration

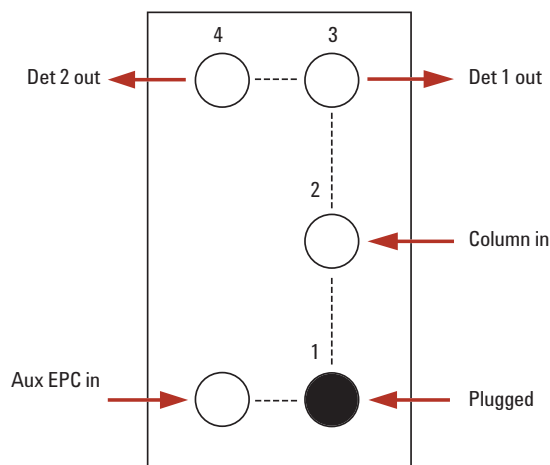

Figure 12. Three-way splitter configured as a two-way splitter

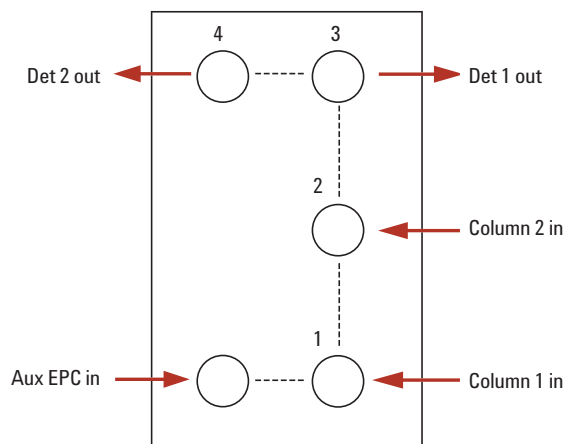
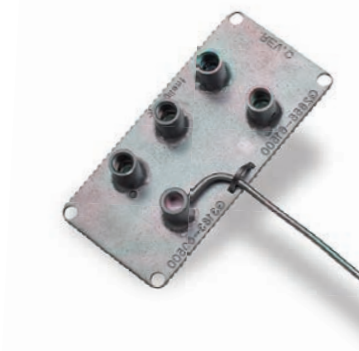

Figure 13. Column 2 is unused

What you need to get faster analysis results



7890 GC or 6890N GC with two or three detectors

Splitter option or accessory

- On-site installation and verification are strongly recommended.

Aux EPC module

- Aux EPC Purge Regulator Kit is recommended.
- PCM can be used in place of Aux EPC but is not recommended for this application.

High-temperature SilTite ferrules and fittings

Deactivated silica tubing for detector restrictors

Splitter calculator software (included with the splitter option and accessory)

- Calculates the restrictor dimensions (internal diameter and length) required to obtain a desired split ratio from the column to the multiple detectors.
- A set of eight typical configurations have been pre-calculated and are available in the operator manual for each of the splitters. They apply to a wide variety of detector combinations and split ratios.

Microsoft® Excel 97 or later

For more information

Read: **Agilent G3181B Two-Way Splitter Kit Without Makeup Gas Installation and Operation Guide Agilent Manual, G3181-90120;**
Agilent G3180B Two-Way Splitter Kit With Makeup Gas Installation and Operation Guide Agilent Manual, G3180-90120;
Agilent G3183B Three-Way Splitter Kit Installation and Operation Guide; Agilent Manual, G3183-90120

Learn more: www.agilent.com/chem/CapillaryFlowTechnology

Buy online or find an Agilent customer center in your country:

www.agilent.com/chem/contactus

U.S. and Canada: **1-800-227-9770** or agilent_inquiries@agilent.com

Europe: info_agilent@agilent.com

Asia Pacific: adinquiry_aplsca@agilent.com

Information, descriptions, and specifications in this publication are subject to change without notice.

© Agilent Technologies, Inc. 2013
Printed in the U.S.A. June 10, 2013
5989-9667EN



Agilent Technologies