

MACHEREY-NAGEL

CHROMAFIL[®] Xtra

Chromatography



Pure Filters

MACHEREY-NAGEL

www.mn-net.com



Contents

Introduction	3
Technical information	5
Specifications	11
Quality control	12
Packages and membranes	13
Chemical compatibility	15
Optimal use of CHROMAFIL®	16
How to select the optimal CHROMAFIL® syringe filter	17
Ordering information	18
CHROMAFIL® – Disposable filters from MACHEREY-NAGEL	31

FilterFinder online

The cross reference for syringe filters
www.mn-net.com/filterfinder



Introduction

CHROMAFIL® – Ideal for GC, HPLC and UHPLC sample filtration

By using CHROMAFIL® syringe filters unwanted particles are removed which can otherwise cause contamination and clogging of sensitive instrumentation. So, filtering your samples leads to an increase of lifetime and less downtime of chromatographic columns and equipment, gives more consistent and reproducible results and thereby saves time and money.

Features

- Different membrane types to meet multiple filtration needs
- Low content of extractable compounds
- Fast flow geometry for easy filtration
- Low hold-up volume for maximum filtrate recovery
- HPLC certified
- Designed to be compatible for the use on all common automated filtration systems, e.g., SOTAX® dissolution systems

Your benefits when using CHROMAFIL® syringe filters

- Protection of sensitive instrumentation
- Less system downtime and increased column lifetime
- Reproducible and reliable analytical results

CHROMAFIL® Xtra

Labeled for method validation and certification

- Xtra imprint for the direct identification of the membrane type, diameter and pore size
- Xtra low bleeding PP housing
- Xtra color-free plain polypropylene





Technical information

- Low content of extractable substances due to a high density polypropylene housing combined with ultrapure filtration membranes.

In comparison to filters made of polycarbonate, polyacrylate or polystyrene, all CHROMAFIL® housings are resistant to nearly all organic solvents. (see list of chemical compatibility on page 15)



HPLC test

Conditions	2 mL of the solvent (specified on top of the chromatograms) were applied to the filter; 100 µL of the filtrate were injected into the HPLC
Eluent A	water
Eluent B	acetonitrile
Gradient	10% → 95% B in 25 minutes
Flow rate	0.5 mL/min
Sensitivity	-5 to 10 mAU at 254 nm
Column	125/4 NUCLEODUR® C ₁₈ Gravity 5 µm (REF 760100.40)

Acetonitrile:

Eluate:

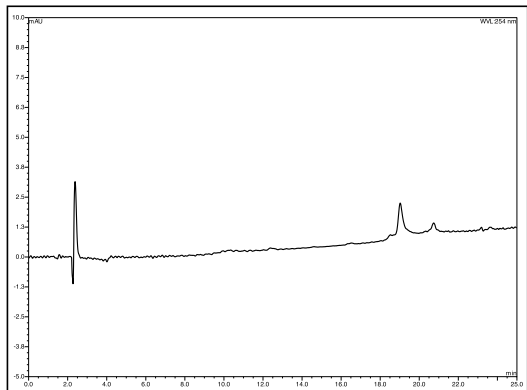

Blank:

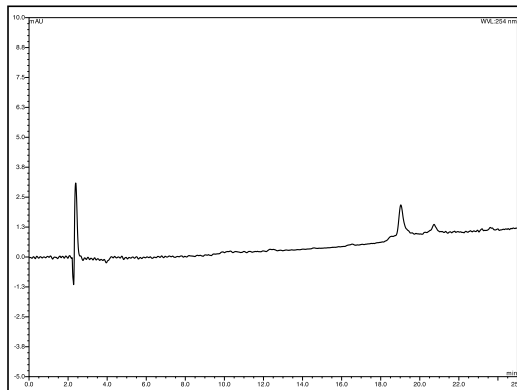

Technical information

Low Bleeding PP housing

Even a treatment with very aggressive solvents / reagents does not lead to significant blind values or extractables.

For proof a filter was rinsed with 0.5 mL MSTFA (*N*-methyl-*N*-trimethylsilyl-trifluoroacetamide), a very powerful silylation reagent. The result is shown in the GC/MS chromatogram.

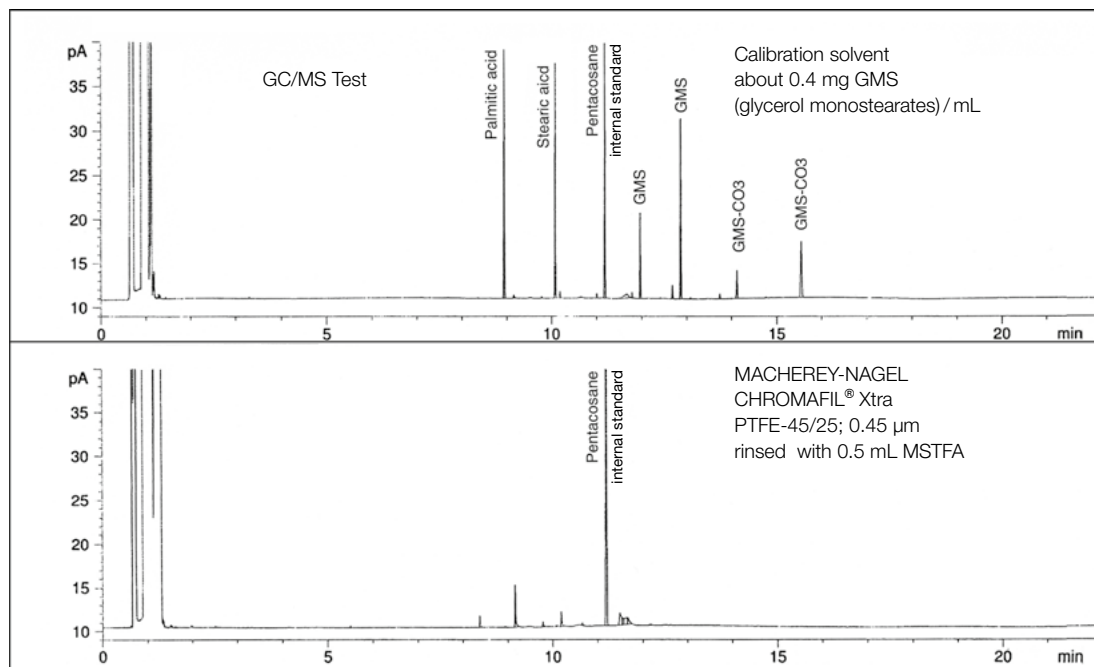

Technical information

Lowest content of extractable substances

- The housing of every CHROMAFIL® filter is ultrasonically sealed.
- The filters are welded, not glued, because glue may have extractable ingredients.
- The welding leads to a tight connection between both parts, thus the filter can be used in both directions. No fluid can leak from the filter housing.

The special thick rim of the housing is ideal for use in laboratory robots (e.g., SOTAX®, Benchmate™, ...).



Luer connection

Luer lock on inlet

- For a safe connection on the “high pressure” side every CHROMAFIL® filter provides a Luer lock on inlet.



Luer outlet

- For the 3, 13 and 25 mm diameter filters: standard Luer outlet. This Luer configuration offers low hold-up volume and easy filtration into autosampler vials and NMR tubes.

Filter inlet and filter outlet can be fitted to all CHROMABOND® columns and accessories for selective sample preparation with the aid of a special adaptor.



Technical information

No breakage of the membrane

- Stabilizing “crash” plate
- The sample fluid is deviated in four lanes by the “crash” plate and does not directly hit the membrane. The resulting pressure distribution protects the membrane against breakage.

Optimal flow geometry

- By star-shaped distribution plate
- The fluid penetrates the membrane on the whole surface, not only on a small area; the filter will not clog rapidly, which guarantees a high flow efficiency.

Different pore sizes

- For multiple filtration application
- Available pore sizes 0.2 and 0.45 μm (additional: PET filters with 1.2 μm , glass fiber filters with 1 μm , PES filters with 5 μm). Filters with 0.45 μm pore size remove fine particles which can clog chromatography columns. 0.2 μm pore size filters are recommended for the filtration of UHPLC samples.

Combi filters

- For solutions with a high load of particulate matter



Technical information

Filter Sizes

3, 13 and 25 mm are the effective membrane diameters. The small diameter filters are especially recommended for very small samples, which require extremely low dead volumes.

Sample volume	Recommended membrane diameter	Dead volume	Filtration area
≥ 1 mL	3 mm	5 µL	0.07 cm ²
15 mL	13 mm	30 µL	1.33 cm ²
5–100 mL	25 mm	80 µL	4.91 cm ²

All filters can be autoclaved at 121 °C and 1.1 bar for 30 min.

25 mm CHROMAFIL® filters are designed to be 100 % compatible and reliable for use with the SOTAX® AT70 smart fully automated dissolution testing systems.



Outer dimensions of 25 mm and 13 mm CHROMAFIL® filters

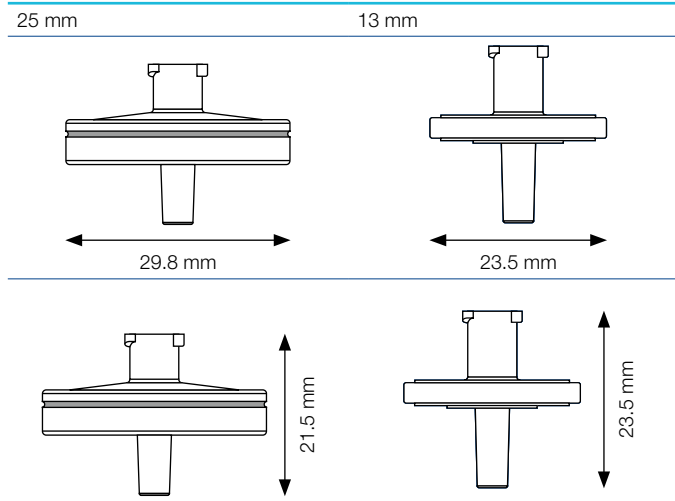



Specifications

Enhanced quality control for better results

MN certifies CHROMAFIL[®] syringe filters to be low in UV absorbing extractables.

All filters and membrane types have been HPLC tested for compatibility with the most common HPLC solvents (methanol, water, acetonitrile, see test chromatograms).

HPLC-test certificates are available for every membrane type.

Please visit: www.mn-net.com

MACHERY-NAGEL

Specification

Product: CHROMAFIL[®] Xtra PET
REF: 729220

Technical Data

Housing material	Polypropylene (PP)
Labeling	Membrane type imprinted on filter top
Membrane filter material	Polycarbonate
Pore diameter	0.45 µm
Filter diameter	25 mm
Filtration area	~ 4.9 cm ²
Pressure stability	> 12 bar
Connections inlet	Female Luerlock
Connections outlet	Male Luer
Dead volume	~ 90 µL

HPLC test

Conditions: Two mL of the solvent (specified under the chromatogram) were applied to the filter. 100 µL of the filtrate were injected into the HPLC.

Eluent A	Water
Eluent B	Acetonitrile
Gradient	10% → 90% B in 25 minutes
Flow rate	0.5 mL/min
Sensitivity	~ 0.10 mAU at 254 nm
Column	1254 NUCLEODUR [®] C ₁₈ Gravity 5 µm (REF: 7910140)

Chromatogram:

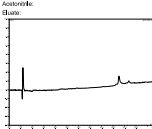
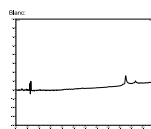



www.mn-net.com

	MACHERY-NAGEL GmbH & Co. KG, Neumann-Neudorfer Str. 6-8, 35222 Eschen, Germany	DE	+49 52 936 30 00	+49 52 936 30 00	+49 52 936 30 00	+49 52 936 30 00
	DE	DE	+49 52 936 30 00	+49 52 936 30 00	+49 52 936 30 00	+49 52 936 30 00
	FR	FR	+33 52 936 30 00	+33 52 936 30 00	+33 52 936 30 00	+33 52 936 30 00
	UK	UK	+44 148 621 1588	+44 148 621 1588	+44 148 621 1588	+44 148 621 1588
	US	US	+1 888 621 1588	+1 888 621 1588	+1 888 621 1588	+1 888 621 1588
	JP	JP	+81 52 936 30 00	+81 52 936 30 00	+81 52 936 30 00	+81 52 936 30 00

	MACHERY-NAGEL GmbH & Co. KG, Neumann-Neudorfer Str. 6-8, 35222 Eschen, Germany	DE	+49 52 936 30 00	+49 52 936 30 00	+49 52 936 30 00	+49 52 936 30 00
	DE	DE	+49 52 936 30 00	+49 52 936 30 00	+49 52 936 30 00	+49 52 936 30 00
	FR	FR	+33 52 936 30 00	+33 52 936 30 00	+33 52 936 30 00	+33 52 936 30 00
	UK	UK	+44 148 621 1588	+44 148 621 1588	+44 148 621 1588	+44 148 621 1588
	US	US	+1 888 621 1588	+1 888 621 1588	+1 888 621 1588	+1 888 621 1588
	JP	JP	+81 52 936 30 00	+81 52 936 30 00	+81 52 936 30 00	+81 52 936 30 00

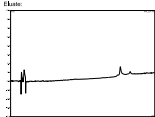
Methanol
Eluate:



Water
Eluate:



Acetonitrile
Eluate:

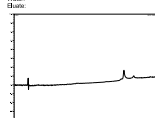

Water
Eluate:

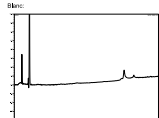

Visit our Online Application Database: www.mn-net.com/apps

2000 free chromatography applications – without registration

... find your application!

www.mn-net.com

	MACHERY-NAGEL GmbH & Co. KG, Neumann-Neudorfer Str. 6-8, 35222 Eschen, Germany	DE	+49 52 936 30 00	+49 52 936 30 00	+49 52 936 30 00	+49 52 936 30 00
	DE	DE	+49 52 936 30 00	+49 52 936 30 00	+49 52 936 30 00	+49 52 936 30 00
	FR	FR	+33 52 936 30 00	+33 52 936 30 00	+33 52 936 30 00	+33 52 936 30 00
	UK	UK	+44 148 621 1588	+44 148 621 1588	+44 148 621 1588	+44 148 621 1588
	US	US	+1 888 621 1588	+1 888 621 1588	+1 888 621 1588	+1 888 621 1588
	JP	JP	+81 52 936 30 00	+81 52 936 30 00	+81 52 936 30 00	+81 52 936 30 00

	MACHERY-NAGEL GmbH & Co. KG, Neumann-Neudorfer Str. 6-8, 35222 Eschen, Germany	DE	+49 52 936 30 00	+49 52 936 30 00	+49 52 936 30 00	+49 52 936 30 00
	DE	DE	+49 52 936 30 00	+49 52 936 30 00	+49 52 936 30 00	+49 52 936 30 00
	FR	FR	+33 52 936 30 00	+33 52 936 30 00	+33 52 936 30 00	+33 52 936 30 00
	UK	UK	+44 148 621 1588	+44 148 621 1588	+44 148 621 1588	+44 148 621 1588
	US	US	+1 888 621 1588	+1 888 621 1588	+1 888 621 1588	+1 888 621 1588
	JP	JP	+81 52 936 30 00	+81 52 936 30 00	+81 52 936 30 00	+81 52 936 30 00

A specification data sheet is available for all membranes and filter diameters.

Quality control

Pressure stability of CHROMAFIL®

The syringe filter housing is stable up to 12 bar. The “blue” test - membrane, pressure and filtration batch test - with blue colored silica particles in matching particle sizes provides an excellent method to find leaks or membrane deviations.



Packages and membranes

Package sizes

- Packs of 100 or 400 (BIGboxes) for 25 mm Ø filter
- Packs of 100 for 13 mm Ø filter
- Packs of 100 for 3 mm Ø filter
- Packs of 50 for sterile filter



Different membrane materials

Depending on your filtration task you can choose filter membranes made from different materials:

Polyester	(PET) with or without glass fiber prefilter*
Regenerated cellulose	(RC) with or without glass fiber prefilter*
Polytetrafluoroethylene	(PTFE) with or without glass fiber prefilter*
Hydrophilized Polytetrafluoroethylene	(H-PTFE)
Cellulose mixed esters	(MV)
Cellulose acetate	(CA) sterile and non-sterile
Polyamide / Nylon	(PA) with or without glass fiber prefilter*
Polyethersulfone	(PES)
Polyvinylidene difluoride	(PVDF) with or without glass fiber prefilter*
Glass fiber	(GF)

* Filters with (nom. 1 µm) GF prefilter provide a 2-4 times greater throughput than filters without prefilter for extremely viscous and most difficult-to-filter samples

Packages and membranes

Combi syringe filters

Benefits

- A coarse glass fiber (GF) prefilter and a small-pore membrane as main filter
- For solutions with a high load of particulate matter: lower back pressure, easy filtration
- For high yields of filtrate: more mL of pure filtrate per filter

The technology

The glass fiber membrane (1 μm) removes coarse particles, before they can block the fine main membrane. This results in a better filtration efficiency, particularly for highly contaminated samples.

Housing	solvent-resistant, ultra low bleed polypropylene
Inlet	Luer lock
Outlet	Luer
Pore diameter	1.0/0.20 μm or 1.0/0.45 μm
Filter diameter	25 mm
Void volume	< 80 μL
Packing unit	100 filters / BIGboxes with 400 filters

Available membranes with GF-prefilter

- Polyester (PET)
- Regenerated cellulose (RC)
- Polyvinylidene difluoride (PVDF)
- Polytetrafluoroethylene (PTFE)
- Polyamide / Nylon (PA)

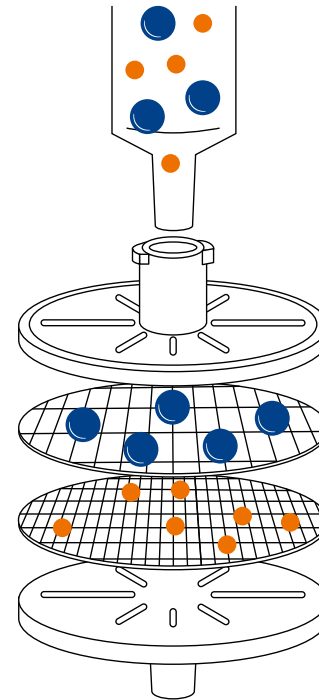

Chemical compatibility

Solvent	Material MV	CA	RC	PA	PTFE	H-PTFE	PVDF	PES	PET	GF	IC	PP
Acetaldehyde	-	-	+	○	+	+	+		+	+		○
Acetic acid, 100 %	-	-	-	-	+	+	+	+	+	+		+
Acetone	-	-	+	+	+	+	-	-	+	+		+
Acetonitrile	-	-	+	+	+	+	+	+	+	+		+
Ammonia, 25 %	-	-	○	-	+	+	+	+	○	+	-	+
Benzene	+	+	+	+	+	+	○	+	+	+		○
<i>n</i> -Butanol	+	+	+	○	+	+	+	+	+	+		+
Cyclohexane	+	+	+	○	+	+	+	+	+	+		+
Dichloromethane	+	-	+	-	+	+	+	-	+	+		-
Diethyl ether	○	○	+	+	+	+	+	+	+	+		○
Dimethylformamide	-	-	○	+	+	+	-	-	+	+		+
1,4-Dioxane	-	-	+	+	+	+	○	-	+	+		○
Ethanol	-	+	+	+	+	+	+	+	+	+		+
Ethyl acetate	-	-	+	+	+	+	+	+	+	+		○
Ethylene glycol	○	○	+	+	+	+	+	+	+	+		+
Formic acid, 100 %	+	-	○	-	+	+	+	+	○	+		+
Hydrochloric acid, 30 %	-	-	-	-	+	+	+	+	-	+	-	+
Methanol	-	-	+	+	+	+	+	+	+	+		+
Nitric acid, 65 %	-	-	-	-	○	○	○	-	○	+	-	-
Oxalic acid, 10 % aqueous	+	-	+	-	+	+	+	○	+	+		+
Petroleum ether	+	+	+	+	+	+	+	+	+	+		+
Phosphoric acid, 80 %	-	-	○	-	+	+	○	-	+	+	-	+
Potassium hydroxide, 1 mol/L	-	-	○	+	+	+	○	○	○	○	+	+
2-Propanol	+	+	+	+	+	+	+	+	+	+		+
Sodium hydroxide, 1 mol/L	-	-	○	+	+	+	○	○	○	○	+	+
Tetrachloromethane	+	-	+	+	+	+	○	-	+	+		○
Tetrahydrofuran	-	-	+	○	+	+	+	-	+	+		○
Toluene	+	-	+	+	+	+	+	+	+	+		○
Trichloroethene	+	+	+	○	+	+	+	○	+	+		○
Trichloromethane (chloroform)	+	-	+	-	+	+	+	-	+	+		-
Urea	+	+	+	+	+	+	+	+	+	+		+
Water	+	+	+	+	+	+	+	+	+	+	+	+
Xylene	+	+	+	+	+	+	○	○	+	+		○

Data not guaranteed

+ resistant

- not resistant

○ limited resistance

Material
Membranes

MV = cellulose mixed esters

CA = cellulose acetate

RC = regenerated cellulose

PA = polyamide

PTFE = polytetrafluoroethylene

H-PTFE = hydrophilized polytetrafluoroethylene

PVDF = polyvinylidene difluoride

PES = polyethersulfone

PET = polyester

GF = glass fiber

IC = special filter for ion chromatography

Housing material

PP = polypropylene

Optimal use of CHROMAFIL®

For achieving the full benefits of filtration we recommend the following instructions.



Draw up the sample into the syringe. Then draw approximately 1 mL of air into the syringe. The air helps to minimize the remaining fluid in the filter.

Plug the CHROMAFIL® syringe filter onto the syringe with the Luer connection. Ensure a tight connection by turning gently.

Start with gentle pressure to filter your sample into a vial*. This helps to assure maximum throughput.

Tips / additional information

We recommend either discarding the first 1 mL or rinsing the filter unit with 1 mL of primary solvent before sample filtration.

In order to avoid the breakage of the membrane only syringes with volumes of 10 mL or higher should be used.

Do not reuse syringe filters

Do not use at temperatures above 55 °C (131°F)

Warning: CHROMAFIL® syringe filters are intended for laboratory use only. Do not use CHROMAFIL® syringe filters for direct patient care applications.

* MACHEREY-NAGEL offers a wide range of vials and caps. More information at www.mn-net.com/vials

How to select the optimal CHROMAFIL® syringe filter

1. Filter size

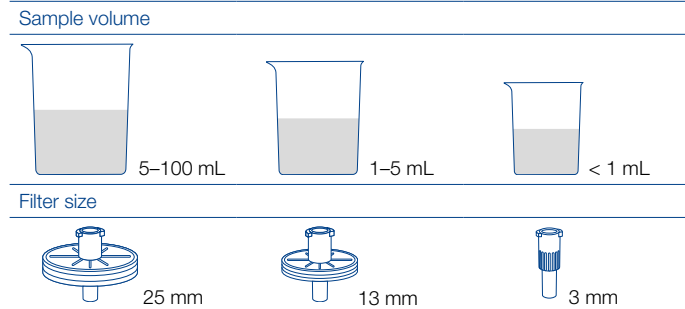

2. Pore size of filter membrane

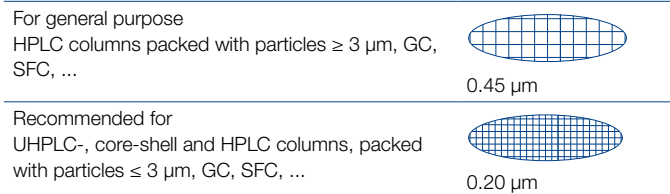

3. Membrane type

Properties of sample	Recommended	Alternatives
Aqueous, polar hydrophilic low particle-load high particle-load, prefiltration required	PET GF/PET	H-PTFE, MV, RC GF/RC, GF/PVDF
Mid-polar e.g. HPLC eluents low particle-load high particle-load, prefiltration required	PET GF/PET	PA, RC GF/PA
Proteins low binding capacity of proteins high binding capacity of proteins	CA GF	PVDF, PES GF/PVDF, GF/PET
Strong acids and bases low particle-load high particle-load, prefiltration required	H-PTFE GF/PTFE	PTFE GF
Organic, nonpolar, hydrophob low particle-load high particle-load, prefiltration required	PTFE GF/PTFE	PET GF/PET, GF/PVDF
Aqueous, for ion chromatography determinations	IC	

Ordering information

Polyester (PET)

- Hydrophilic multipurpose membrane
- For polar as well as nonpolar solvents
- The HPLC filter, especially suited for mixtures of water and organic solvents for TOC / DOC determination, not cytotoxic, does not inhibit the growth of microorganisms and higher cells
- PET filters with integrated glass fiber prefilter* (GF / PET) are recommended for solutions with a high load of particulate matter or for highly viscous solutions



	Type	Pore size [µm]	Membrane diameter [mm]	Color code top	bottom	Standard pack filters / pack	REF	BIGbox filters / pack	REF	
	Xtra PET-20/25	0.20	25	labeled		100	729221	400	729221.400	
	Xtra PET-45/25	0.45	25	labeled		100	729220	400	729220.400	
	Xtra PET-120/25	1.2	25	labeled		100	729229	400	729229.400	
	Xtra PET-20/13	0.20	13	labeled		100	729222			
	Xtra PET-45/13	0.45	13	labeled		100	729223			
	Combi Filters									
	GF/PET-20/25	1.0/0.20	25	blue	orange	100	729032	400	729032.400	
	GF/PET-45/25	1.0/0.45	25	black	orange	100	729033	400	729033.400	

* Glass fiber exhibits a high protein-binding capacity.

Ordering information

Regenerated cellulose (RC)

- Hydrophilic membrane with very low adsorption
- For aqueous and organic / aqueous liquids, i.e. polar and medium polar sample solutions
- Binding capacity for proteins 84 µg per 25 mm filter
- RC filters with integrated glass fiber prefilter* (GF / RC) are recommended for solutions with a high load of particulate matter or for highly viscous solutions



	Type	Pore size [µm]	Membrane diameter [mm]	Color code		Standard pack		BIGbox		
				top	bottom	filters / pack	REF	filters/pack	REF	
	Xtra RC-20/25	0.20	25	labeled		100	729230	400	729230.400	
	Xtra RC-45/25	0.45	25	labeled		100	729231	400	729231.400	
	Xtra RC-20/13	0.20	13	labeled		100	729236			
	Xtra RC-45/13	0.45	13	labeled		100	729237			
	Combi filters									
	GF/RC-20/25	1.0/0.20	25	blue	blue	100	729050	400	729050.400	
	GF/RC-45/25	1.0/0.45	25	black	blue	100	729051	400	729051.400	



* Glass fiber exhibits a high protein-binding capacity.

Ordering information

Polytetrafluoroethylene (PTFE)

- Hydrophobic membrane
- For nonpolar liquids and gases
- Very resistant to all kinds of solvents as well as acids and bases; flushing with alcohol, followed by water, makes the originally hydrophobic membrane more hydrophilic
- PTFE filters with integrated glass fiber prefilter* (GF / PTFE) are recommended for solutions with a high load of particulate matter or for highly viscous solutions

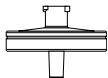

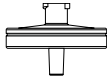
	Type	Pore size [µm]	Membrane diameter [mm]		Standard pack filters / pack	REF	BIGbox filters / pack	REF
	Xtra PTFE-20/25	0.20	25	labeled	100	729207	400	729207.400
	Xtra PTFE-45/25	0.45	25	labeled	100	729205	400	729205.400
	Xtra PTFE-100/25	1.00	25	labeled	100	729247		
	Xtra PTFE-20/13	0.20	13	labeled	100	729208		
	Xtra PTFE-45/13	0.45	13	labeled	100	729209		
	O-20/3	0.20	3		100	729014		
	O-45/3	0.45	3		100	729015		
	Combi Filters							
	Xtra GF/PTFE-20/25	1.0/0.20	25	labeled	100	729270		
	Xtra GF/PTFE-45/25	1.0/0.45	25	labeled	100	729271		



* Glass fiber exhibits a high protein-binding capacity.

Ordering information

Hydrophilized polytetrafluoroethylene (H-PTFE)

- Hydrophobic membrane with additional hydrophilic properties
- For polar and nonpolar sample solutions
- Resistant to all kinds of solvents as well as acids and bases

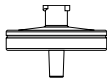

	Type	Pore size [µm]	Membrane diameter [mm]		Standard pack filters / pack	REF	BIGbox filters / pack	REF
	Xtra H-PTFE-20/25	0.20	25	labeled	100	729245		
	Xtra H-PTFE-45/25	0.45	25	labeled	100	729246	400	729246.400
	Xtra H-PTFE-20/13	0.20	13	labeled	100	729256		
	Xtra H-PTFE-45/13	0.45	13	labeled	100	729257		

Ordering information

Cellulose mixed ester (MV)

- Hydrophilic membrane with very low adsorption
- For aqueous or polar solutions



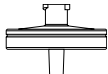

Type	Pore size [µm]	Membrane diameter [mm]	Standard pack filters / pack	REF	BIGbox filters / pack	REF	
 Xtra MV-20/25	0.20	25	labeled	100	729206		
Xtra MV-45/25	0.45	25	labeled	100	729204	400	729204.400

Ordering information

Cellulose acetate (CA)

- Hydrophilic membrane
- For the filtration of water-soluble oligomers and polymers, especially suited for biological macromolecules
- Very high stability in aqueous solutions
- Binding capacity for proteins 21 µg per 25 mm filter
- Also available in a sterile package (S) for filtration under sterile conditions (each filter individually sealed)

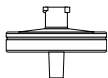

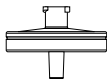

	Type	Pore size [µm]	Membrane diameter [mm]	Color code		Standard pack filters / pack	REF	BIGbox filters / pack	REF	
				top	bottom					
	Xtra CA-20/25	0.20	25	labeled		100	729226	400	729226.400	
	Xtra CA-45/25	0.45	25	labeled		100	729227	400	729227.400	
	Xtra CA-20/13	0.20	13	labeled		100	729254			
	Xtra CA-45/13	0.45	13	labeled		100	729255			
	Sterile filters									
	CA-20/25 (S)	0.20	25	yellow	red	50	729024			
	CA-45/25 (S)	0.45	25	colorless	red	50	729025			

Ordering information

Polyamide (PA) = Nylon

- Moderately hydrophilic membrane
- For aqueous and organic / aqueous medium polar liquids
- PA filters with integrated glass fiber prefilter* (GF / PA) are recommended for solutions with a high load of particulate matter or for highly viscous solutions

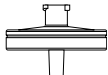

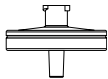
Type	Pore size [µm]	Membrane diameter [mm]	Standard pack filters / pack	REF	BIGbox filters / pack	REF			
	Xtra PA-20/25	0.20	25	labeled	100	729212	400	729212.400	
	Xtra PA-45/25	0.45	25	labeled	100	729213	400	729213.400	
	Xtra PA-20/13	0.20	13	labeled	100	729248			
	Xtra PA-45/13	0.45	13	labeled	100	729249			
	AO-20/3	0.20	3		100	729010			
	AO-45/3	0.45	3		100	729011			
Combi Filters									
	Xtra GF/PA-20/25	1.0/0.20	25	labeled	100	729260			
	Xtra GF/PA-45/25	1.0/0.45	25	labeled	100	729261			

Ordering information

Polyethersulfone (PES)

- Hydrophilic membrane
- For aqueous and slightly organic liquids with higher flow rates
- Very low adsorption for pharmaceuticals and proteins
- Good stability against organic acids and bases
- Binding capacity for proteins 29 µg per 25 mm filter



	Type	Pore size [µm]	Membrane diameter [mm]		Standard pack filters / pack	REF	BIGbox filters / pack	REF
	Xtra PES-20/25	0.20	25	labeled	100	729240		
	Xtra PES-45/25	0.45	25	labeled	100	729241	400	729241.400
	Xtra PES-500/25	5.0	25	labeled	100	729242		

Ordering information

Polyvinylidene difluoride (PVDF)

- Hydrophilic membrane
- For 100 % aqueous solutions, water-soluble oligomers and polymers like proteins
- Low binding capacity for proteins 20 µg per 25 mm filter
- PVDF filters with integrated glass fiber prefilter* (GF / PVDF) are recommended for the filtration of biological samples with high particle loads



	Type	Pore size [µm]	Membrane diameter [mm]	Color code top	Color code bottom	Standard pack filters / pack	REF	BIGbox filters / pack	REF
	Xtra PVDF-20/25	0.20	25	labeled		100	729218	400	729218.400
	Xtra PVDF-45/25	0.45	25	labeled		100	729219	400	729219.400
	Xtra PVDF-20/13	0.20	13	labeled		100	729243		
	Xtra PVDF-45/13	0.45	13	labeled		100	729244		
	Combi filters								
	GF/PVDF-45/25	1.0/0.45	25	black	white	100	729039	400	729039.400



* Glass fiber exhibits a high protein-binding capacity.

Ordering information

Glass fiber (GF)

- Inert filter, nominal pore size 1 μm , allows higher flow rates than small pore filters
- For solutions with high loads of particulate matter or for highly viscous solutions (e.g. soil samples, fermentation broths)
- As prefilters for other CHROMAFIL® filters, they prevent the clogging of the membrane
- High binding capacity for proteins

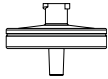

Type	Pore size [μm]	Membrane diameter [mm]	Standard pack filters / pack	REF	BIGbox filters / pack	REF
 Xtra GF-100/25	nom. 1.0	25	labeled	100	729228	400 729228.400
 Xtra GF-100/13	nom. 1.0	13	labeled	100	729234	

Ordering information

Ion chromatography (IC)

- Special filter for ion chromatography
- For the filtration of aqueous liquids
- For optimal results with blind values < 5 ppb we recommend to pre-wash the filter with de-ionized water

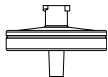

Type	Pore size [μm]	Membrane diameter [mm]	Standard pack filters / pack	REF
 Xtra IC-45/25	0.45	25	labeled	729258



Polypropylene vials for ion chromatography

- 1.5 mL PP screw neck vial with filling lines (702500) often used with 702288.1 in IC on Dionex® instruments
- 0.3 mL transparent vials with inner cone, screw neck N 9 (702009) or snap ring / crimp neck N 11 (702809); also available in amber
- 0.7 mL transparent vials with round bottom insert, screw neck N 9 (702010) or snap ring / crimp neck N 11 (702174)



Ordering information

Filtration cartridges

- Filtration cartridges for sample clarification under vacuum (e.g., using the CHROMABOND® vacuum manifold or SPE automation systems like Gilson Aspec™, Rapidtrace) or by gravity flow.
- Cartridge sizes 3 mL and 6 mL
- Different membranes (PET, RC, PTFE, PVDF, GF) and pore sizes (0.20, 0.45 and 1.0 µm). The membrane materials correspond to the respective CHROMAFIL® syringe filters.

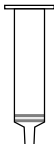

	Type	Pore size [µm]	Pack of	Column volume	
				REF 3 mL	REF 6 mL
	PET (polyester)	0.20	100	730578.320	730578.620
	PET (polyester)	0.45	100	730578.345	730578.645
	RC (regenerated cellulose)	0.20	100	730068.320	730068.620
	RC (regenerated cellulose)	0.45	100	730068.345	730068.645
	PTFE (polytetrafluoroethylene)	0.20	100	730570.320	730570.620
	PTFE (polytetrafluoroethylene)	0.45	100	730570.345	730570.645
	PVDF (polyvinylidene difluoride)	0.20	100	730579.320	730579.620
	PVDF (polyvinylidene difluoride)	0.45	100	730579.345	730579.645
	GF (glass fiber)	nom. 1.0	100	730517.3100	730517.6100

Ordering information

MULTI 96 filter plates

- 96-well polypropylene plates for the simultaneous filtration of 96 samples
- Advantages of this high-throughput system:
 - Economical by saving time and solvent
 - Use of multi-channel pipettors facilitates liquid transfer steps
 - Readily adaptable to all common automated/robotic handling systems
 - Minimized dead volume (= 40 µL)
- Membrane materials correspond to the respective CHROMAFIL® syringe filters



	Description	Pack of	REF
	Filter plates with cellulose mixed ester filter elements (0.20 µm)	1	738770.M
	Filter plates with cellulose mixed ester filter elements (0.45 µm)	1	738771.M
	Filter plates with RC filter elements (regenerated cellulose, 0.20 µm)	1	738656.M
	Filter plates with RC filter elements (regenerated cellulose, 0.45 µm)	1	738657.M
	Filter plates with PTFE filter elements (0.20 µm)	1	738660.M
	Filter plates with PTFE filter elements (0.45 µm)	1	738661.M
	Filter plates with PTFE filter elements (1.0 µm)	1	738662.M
	Filter plates with PTFE filter elements (3.0 µm)	1	738663.M
	Filter plates with PE filter elements (40–100 µm)	1	738659.M
	Filter plates with glass fiber filter elements (nominal 1 µm)	1	738655.2M
Filter plates with glass fiber filter elements (nominal 3 µm)	1	738658.M	

CHROMAFIL® – Disposable filters from MACHERY-NAGEL



HPLC



GC



TLC



SPE and Flash



Syringe filters



Vials and caps

Germany

MACHERY-NAGEL GmbH & Co. KG
Neumann-Neander-Str. 6–8
52355 Düren · Germany
Tel.: +49 24 21 969-0
Fax: +49 24 21 969-199
info@mn-net.com

France

MACHERY-NAGEL SARL à associé unique
1, rue Gutenberg
67722 Hoerdts · France
Tél. : +33 388 68 22 68
Fax : +33 388 51 76 88
sales-fr@mn-net.com

Switzerland

MACHERY-NAGEL AG
Hirsackerstr. 7
4702 Oensingen · Switzerland
Tel.: +41 62 388 55 00
Fax: +41 62 388 55 05
sales-ch@mn-net.com

USA

MACHERY-NAGEL Inc.
2850 Emrick Blvd.
Bethlehem, PA 18020 · USA
Tel.: +1 484 821 0984
Fax: +1 484 821 1272
sales-us@mn-net.com

Registered and common law trademarks

ASPEC®	Gilson Inc. (USA)
CHROMAFIL®	MACHERY-NAGEL GmbH & Co. KG (Germany)
CHROMABOND®	MACHERY-NAGEL GmbH & Co. KG (Germany)
Dionex®	Dionex Corporation
SOTAX®	Sotax AG (Switzerland)
Benchmate™	Caliper Life Sciences Inc. (USA)

www.mn-net.com

MACHEREY-NAGEL



MACHEREY-NAGEL GmbH & Co. KG · Neumann-Neander-Str. 6-8 · 52355 Düren · Germany

DE / International:

Tel.: +49 24 21 969-0

Fax: +49 24 21 969-199

E-mail: info@mn-net.com

CH:

Tel.: +41 62 388 55 00

Fax: +41 62 388 55 05

E-mail: sales-ch@mn-net.com

FR:

Tel.: +33 388 68 22 68

Fax: +33 388 51 76 88

E-mail: sales-fr@mn-net.com

US:

Tel.: +1 484 821 0984

Fax: +1 484 821 1272

E-mail: sales-us@mn-net.com

